

Lecture 6: Metagaming

- Game Optimization
- Symmetry and Factoring
- Structure Identification
- Evaluation Functions
- Monte Carlo Tree Search

Rule Ordering

Example:

```
ancestor(X, Z) <= parent(X, Y) ^ ancestor(Y, Z)
ancestor(X, Y) <= parent(X, Y)
```

Better Version (for **generating** solutions to ancestor):

```
ancestor(X, Y) <= parent(X, Y)
ancestor(X, Z) <= parent(X, Y) ^ ancestor(Y, Z)
```

Conjunct Ordering (1)

Example:

```
goal(X,Z) <= p(X,Y) ^ q(Y,Z) ^ distinct(Y,b)
```

Better:

```
goal(X,Z) <= p(X,Y) ^ distinct(Y,b) ^ q(Y,Z)
```

Worse:

```
goal(X,Z) <= distinct(Y,b) ^ p(X,Y) ^ q(Y,Z)
```

Domains

The domains of the fluents can be determined from the rules of the game with the help of the **dependency graph**

```
succ(0,1) ∧ succ(1,2) ∧ succ(2,3)  
init(step(0))  
next(step(X)) ≤ true(step(Y)) ∧ succ(Y,X)
```

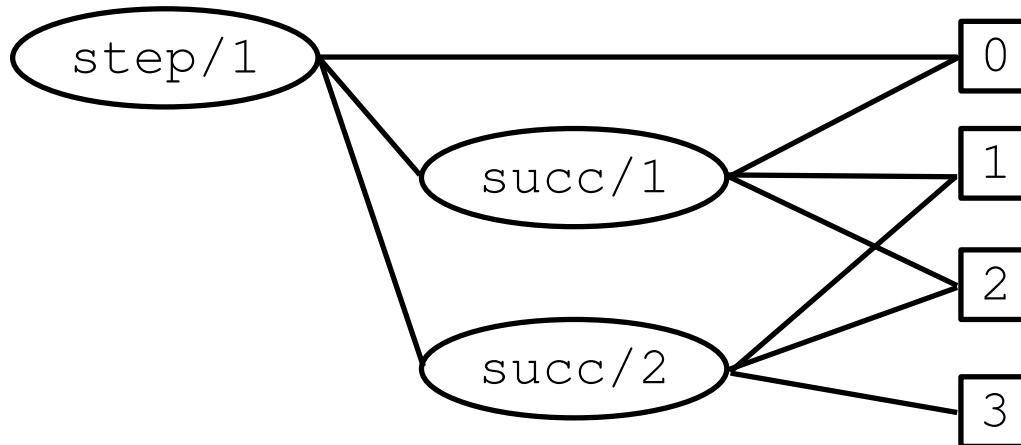

Conjunct Ordering (2)

Example:

```
wins(P) <= true(cell(X,Y,P)) ∧ corner(X,Y) ∧ queen(P)
```

Solution Set Sizes:

```
|true(cell(X,Y,P))| = 768
```

```
|corner(X,Y)| = 4
```

```
|queen(P)| = 2
```

Better Version:

```
wins(P) <= queen(P) ∧ corner(X,Y) ∧ true(cell(X,Y,P))
```

Data Extraction

Original:

$p(10) \leq q(a)$

$p(20) \leq q(b)$

$p(30) \leq q(c)$

$q(X) \leq \dots$

Assumptions:

- q is expensive to compute
- as easy to generate answers as to check answers

New, improved Version:

$p(Y) \leq q(X) \wedge r(X, Y)$

$r(a, 10)$

$r(b, 20)$

$r(c, 30)$

$q(X) \leq \dots$

Database Views

The ancestor relation a is the transitive closure of the parent relation p :

$$\begin{aligned} a(X, Y) &\leq p(X, Y) \\ a(X, Z) &\leq a(X, Y) \wedge a(Y, Z) \end{aligned}$$

The “samefamily” relation sf is true of all pairs of people that are relatives, i.e., that have a common ancestor:

$$sf(Y, Z) \leq a(X, Y) \wedge a(X, Z)$$

Using Materialized Views

$$a(X, Y) \leq p(X, Y)$$

$$a(X, Z) \leq a(X, Y) \wedge a(Y, Z)$$

$$sf(Y, Z) \leq a(X, Y) \wedge a(X, Z)$$

If we materialize the view a or sf then we increase the computational efficiency of answering the query sf .

If we do not materialize the views a or sf then we decrease the amount of database storage space (space economy).

What are the optimal views to materialize? Database reformulation gives answers.

Querying Data Faster: Ideas

How about precomputing all elementary queries?

Not always a great idea (materializing [sf](#))

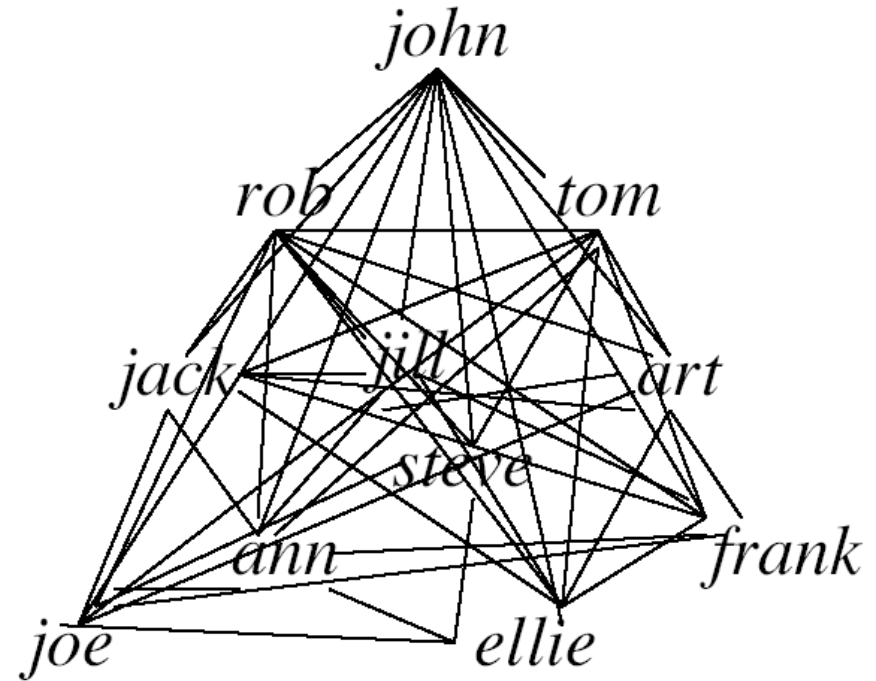
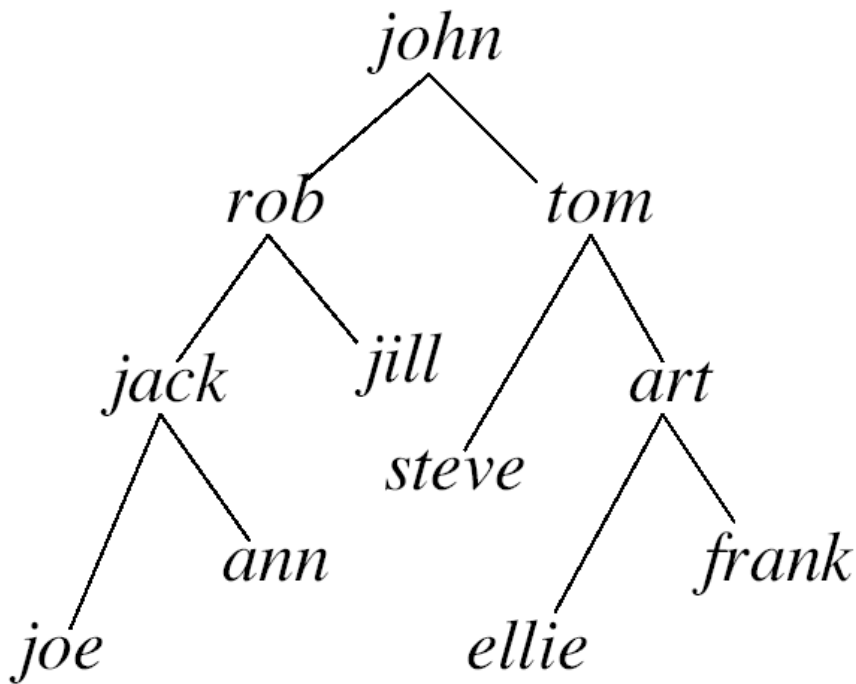

Querying Data Faster: Ideas

How about precomputing predefined views?

Not too good, either (materializing [a](#))

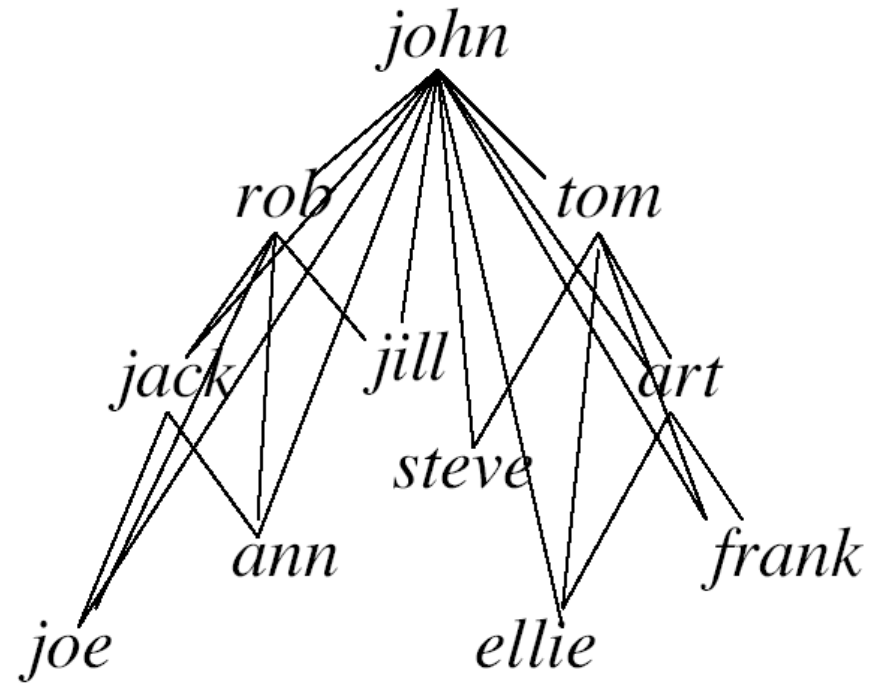
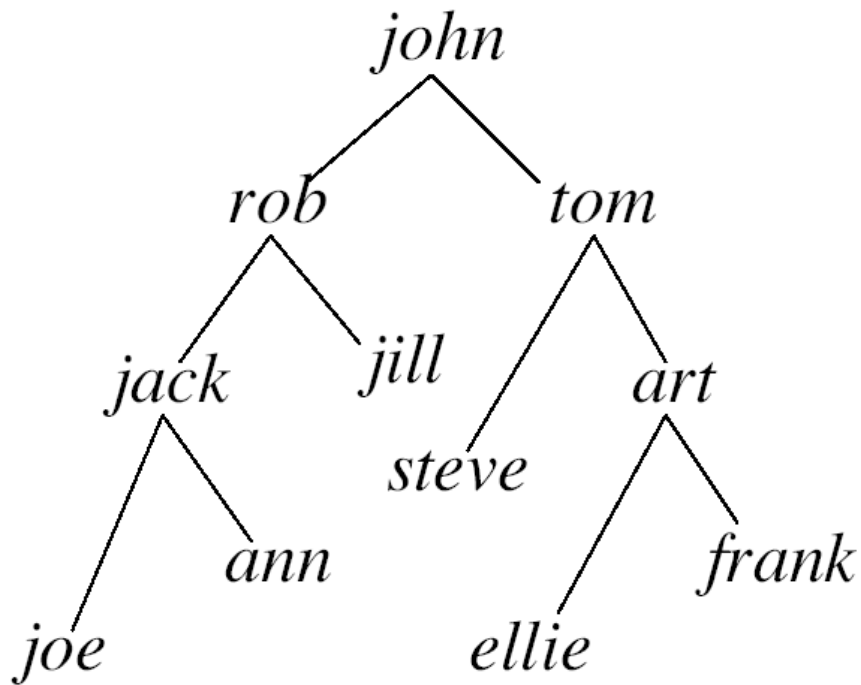

Querying Data Faster: Ideas

How about precomputing “pieces” of the elementary queries?

Materializing new views that are not already defined on the database: *relational reformulation*

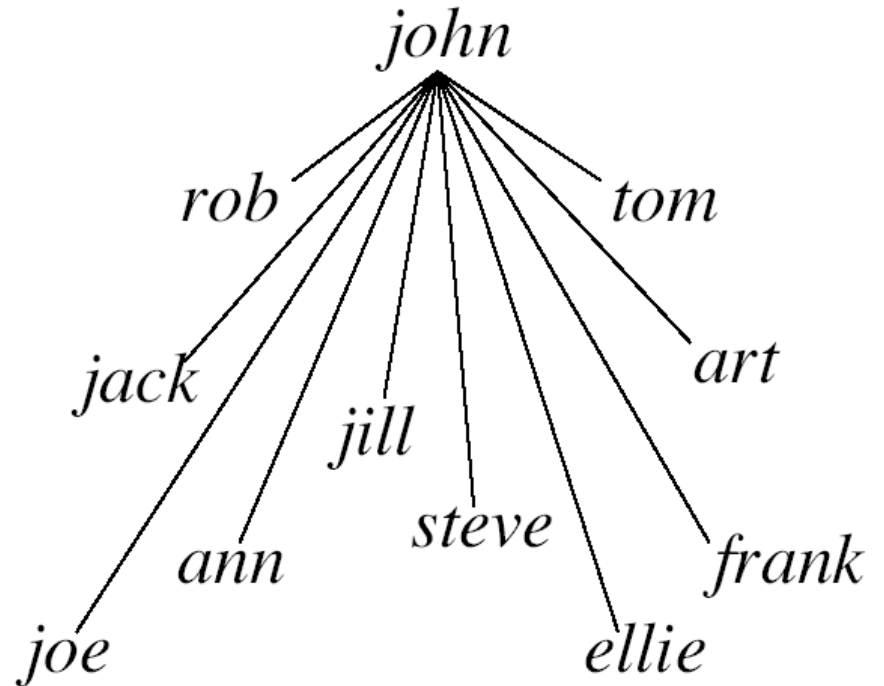
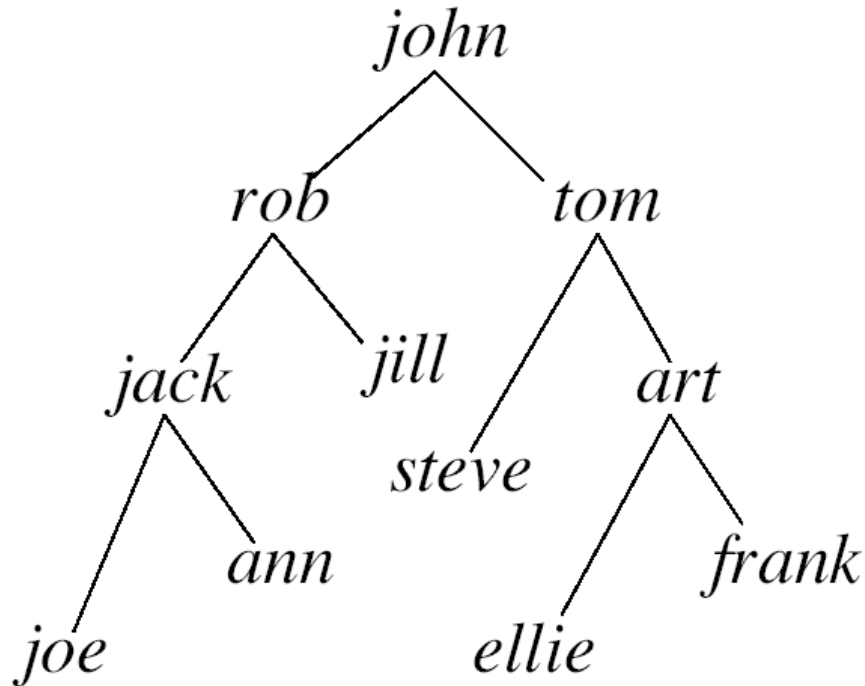

May Need to Invent New Relations

Ancestor a :
 $a(X, Y) \leq p(X, Y)$
 $a(X, Y) \leq a(X, Z) \wedge a(Z, Y)$

Same family sf :
 $sf(X, Y) \leq a(Z, X) \wedge a(Z, Y)$

New: “has parent”
 $hp(X) \leq p(Z, X)$

New: “founding father”
 $ff(X, Y) \leq a(X, Y) \wedge \neg hp(X)$

New: a rewriting of sf in terms of ff :

$sf(X, Y) \leq ff(Z, X) \wedge ff(Z, Y)$

Reformulating Samefamily

Has parent:

$$\text{hp}(X) \leq \text{p}(Z, X)$$

Founding father:

$$\text{ff}(X, Y) \leq \text{a}(X, Y) \wedge \neg \text{hp}(X)$$

A rewriting of *sf* in terms of *ff*:

$$\text{sf}(X, Y) \leq \text{ff}(Z, X) \wedge \text{ff}(Z, Y)$$

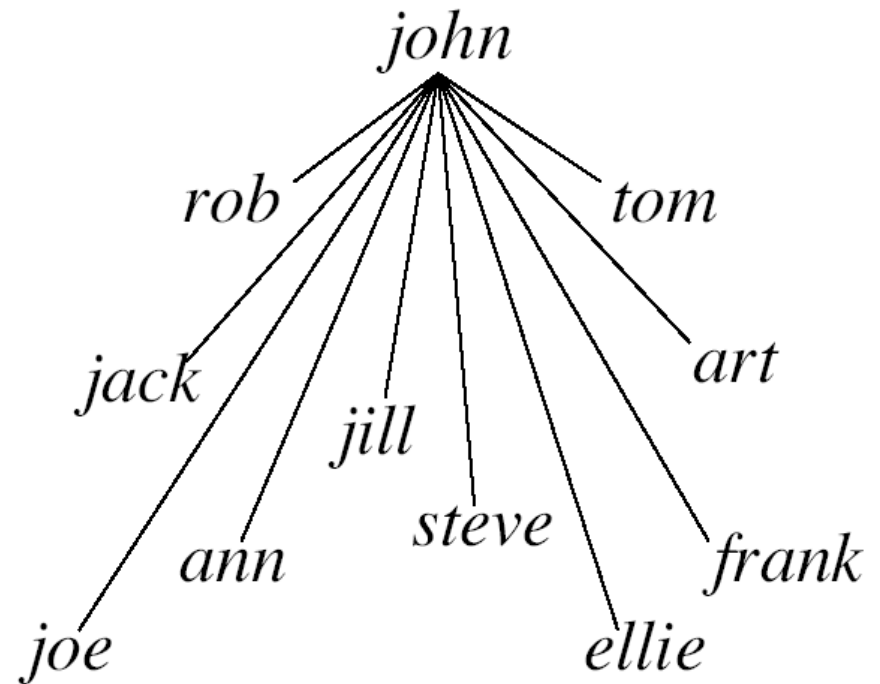
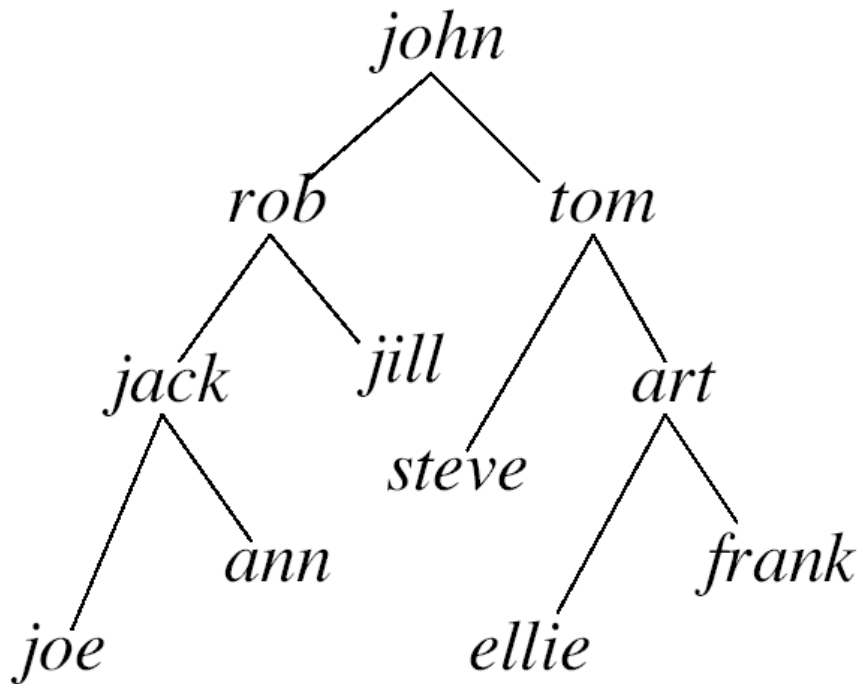

Symmetry

Symmetries can be logically derived from the rules of a game.

A **symmetry relation** over the elements of a domain is an equivalence relation such that

- two symmetric states are either both terminal or non-terminal
- if they are terminal, they have the same goal value
- if they are non-terminal, the legal moves in each of them are symmetric and yield symmetric states

Example: [Individual pebbles in Othello or Go](#)

Reflectional Symmetry

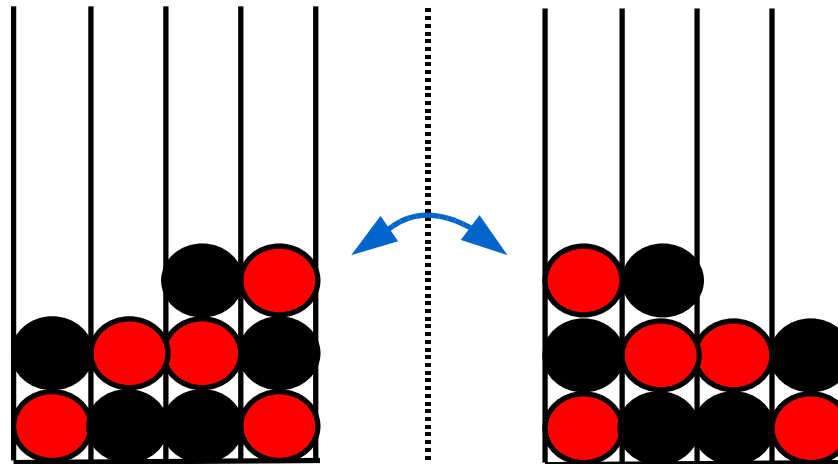

Connect-3

Rotational Symmetry

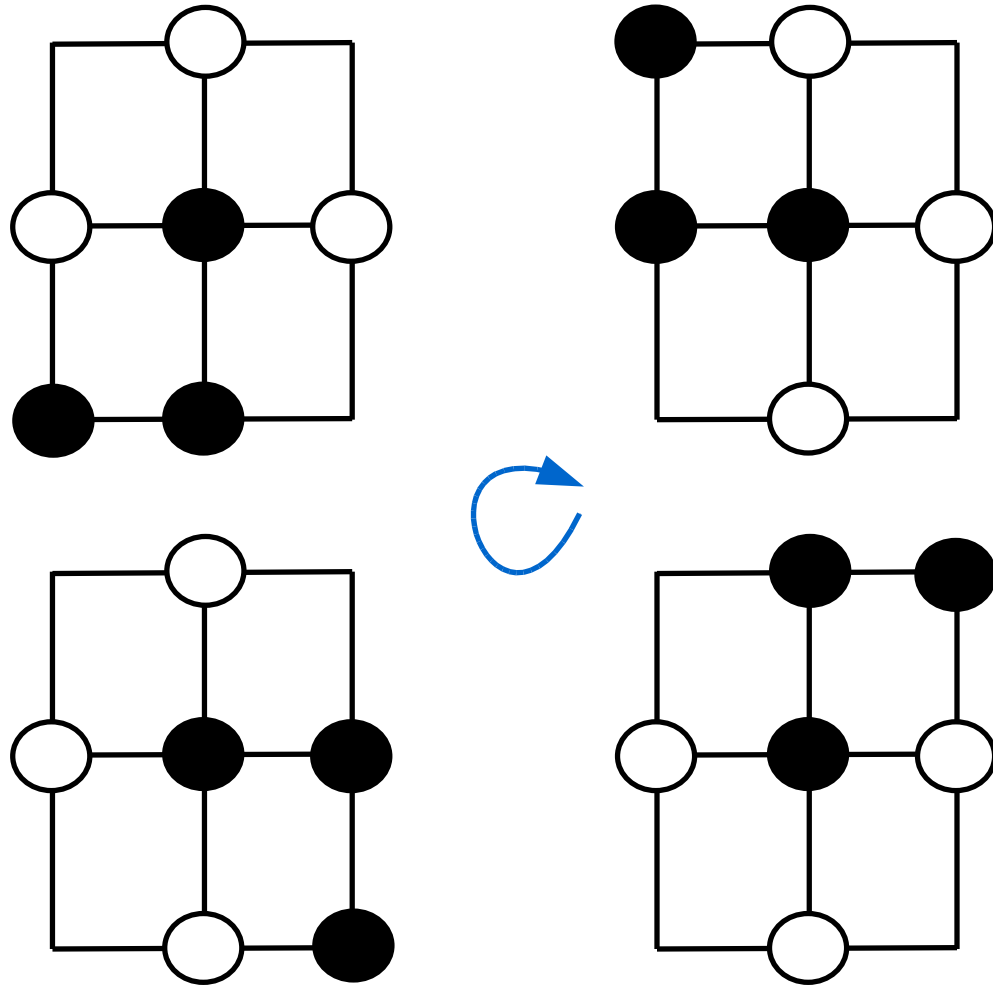

Capture Go

Metagaming

Factoring Example

Hodgepodge = Chess + Othello

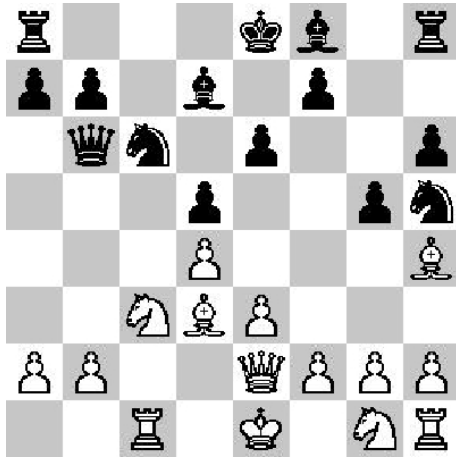

Branching factor: a

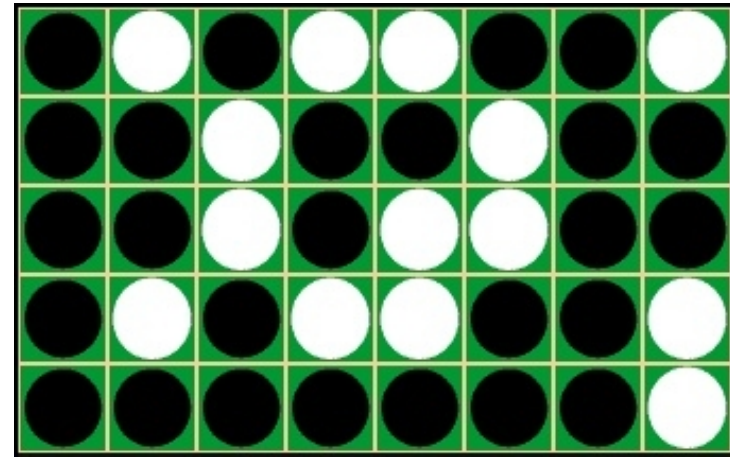

Branching factor: b

Branching factor as given to players: $a * b$

Fringe of tree at depth n as given: $(a * b)^n$

Fringe of tree at depth n factored: $a^n + b^n$

Double Tic-Tac-Toe

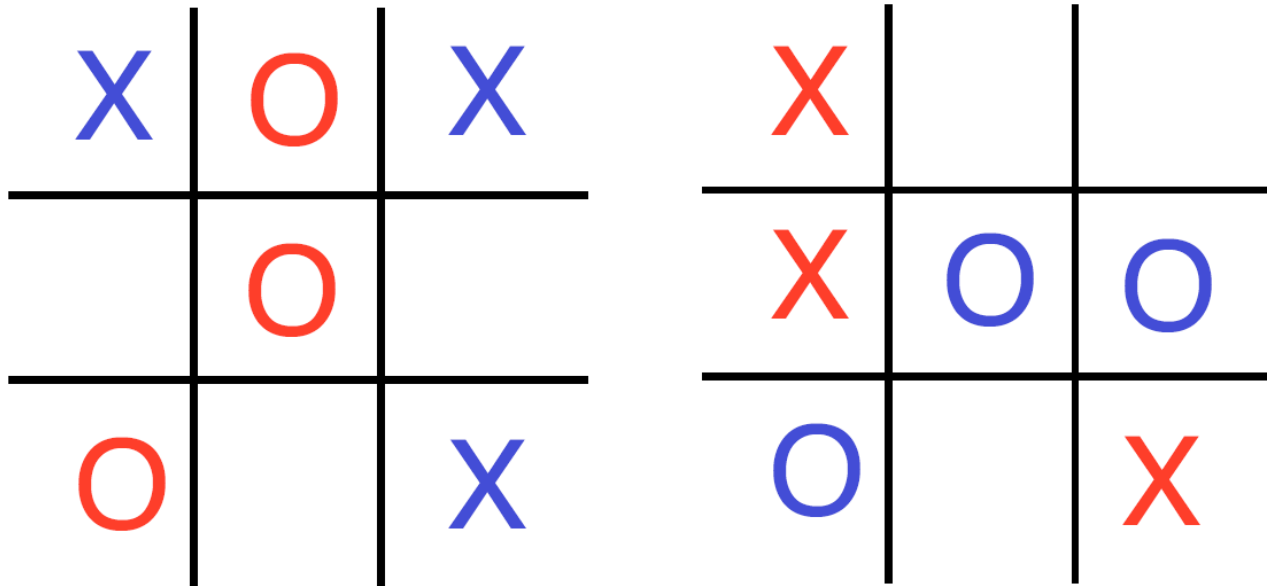

Branching factor: 81, 64, 49, 36, 25, 16, 9, 4, 1

Branching factor (factored): 9, 8, 7, 6, 5, 4, 3, 2, 1 (x 2)

Game Factoring and its Use

1. Compute factors
 - Behavioral factoring
 - Goal factoring
2. Play factors
3. Reassemble solution
 - Append plans
 - Interleave plans
 - Parallelize plans with simultaneous actions

Behavioral Factoring

A set \mathcal{F} of fluents and moves is a *behavioral factor* if and only if there are no connections between the fluents and moves in \mathcal{F} and those outside of \mathcal{F} .

Goal Factoring

Simple Case – goal is a conjunction

- Partition conjuncts over behavioral factors
- Create new goals for each factor

Complex Case – goal is a disjunction of conjunctions

- Split each conjunct as above
- Check for lossless joins, i.e. when recombined, we get the same results

Good:

$$(p1 \wedge q1) \vee (p1 \wedge q2)$$

Bad:

$$(p1 \wedge q1) \vee (p2 \wedge q2)$$

Blind Search

- Blind search: only assign scores to nodes based on the evaluation of the complete subtrees at those nodes
- Problem: can relatively rarely see all the way to the bottom of the tree for a single node, even less so for every successor node
- Solution: improve efficiency of inference
- Solution: assign intermediate scores to nodes based on an **evaluation function**
- **Metagaming** means to reason about properties of games

Designing Evaluation Functions

- Typically designed by programmers/humans
- A great deal of thought and empirical testing goes into choosing one or more good functions
- E.g.
 - piece count, piece values in chess
 - holding corners in Othello
- But this requires knowledge of the game's structure, semantics, play order, etc.

The General Case

- No knowledge of features
- No insight into game structure
- No intuition about what is a good feature for this particular game

- Some general ideas work in many cases – but sometimes they don't ...
- E.g. mobility heuristics, novelty heuristics, goal distance

Mobility

- More moves means better state
Optionally: limiting opponent moves is better too
- The good:
In many games, being cornered or forced into making a move is quite bad
 - In Chess, when you are in check, you can do relatively few things compared to not being in check
 - In Othello, having few moves means you have little control of the board
- The bad: Mobility is disastrous for Checkers

Worldcup 2006: Cluneplayer vs. Fluxplayer

●	BC8	●	DC8	●	FC8	●	HC8
AC7	●	CC7	●	EC7	●	GC7	●
●	BC6	CC6	DC6	●	FC6	●	HC6
AC5	BC5	CC5	●	EC5	FC5	GC5	HC5
AC4	BC4	●	DC4	EC4	FC4	GC4	HC4
AC3	●	CC3	DC3	EC3	●	GC3	●
●	BC2	●	DC2	●	FC2	●	HC2
AC1	●	CC1	●	EC1	●	GC1	●

Piece Count BLACK: 12 RED: 12

Playclock:

Roles:

Red
CLUNEPLAYER

Black
FLUXPLAYER

Last Moves (step 2):

Red
noop

Black
move(bp,c,c6,d,c5)

Inverse Mobility

- Having fewer things to do is better
Optionally: giving opponent things to do is better
- This works in some games, like Nothello, where you might in fact want to *lose pieces*
- How to decide between mobility and inverse mobility heuristics?

Novelty

- Changing the game state is better
- The good:
 - Changing things as much as possible can help avoid getting stuck
 - When it is unclear what to do, maybe the best thing is to throw in some directed randomness
- The bad:
 - Changing the game state can happen if you throw away your own pieces ...
 - Unclear if novelty per se actually goes anywhere useful for anybody

Identifying Structures: Relations

A **successor relation** is a binary relation that is antisymmetric, functional, and injective.

Example:

```
succ(1, 2) ∧ succ(2, 3) ∧ succ(3, 4) ∧ ...  
next(a, b) ∧ next(b, c) ∧ next(c, d) ∧ ...
```

An **order relation** is a binary relation that is antisymmetric and transitive.

Example:

```
lessthan(A, B) ≤ succ(A, B)  
lessthan(A, C) ≤ succ(A, B) ∧ lessthan(B, C)
```

Boards and Pieces

An (m -dimensional) **board** is an n -ary fluent ($n \geq m+1$) with

- m arguments whose domains are successor relations
- 1 output argument

Example:

```
cell(a,1,whiterook) ∧ cell(b,1,whiteknight) ∧ ...
```

A **marker** is an element of the domain of a board's output argument.

A **piece** is a marker which is in at most one board cell at a time.

Example: [Pebbles in Othello](#), [White King in Chess](#)

Goal Distance

- The better an intermediate state satisfies the goal specification, the better it is
- Fuzzy Logic (t-norms) to evaluate a goal formula
- Value $0.5 < p < 1.0$ for true literals (and $1-p$ for false literals)
- Non-standard t-norm with **threshold** to avoid values close to 0 for large conjunctions

$$\begin{aligned}\text{eval}(F \wedge G) &= T(\text{eval}(F), \text{eval}(G)) \\ \text{eval}(F \vee G) &= \text{co-T}(\text{eval}(F), \text{eval}(G)) \\ \text{eval}(\neg F) &= 1 - \text{eval}(F)\end{aligned}$$

Example: Tic-Tac-Toe

```
goal(xplayer, 100) <= true(cell(M, 1, x)) ^  
                      true(cell(M, 2, x)) ^  
                      true(cell(M, 3, x))  
                      v  
                      true(cell(1, N, x)) ^  
                      true(cell(2, N, x)) ^  
                      true(cell(3, N, x))  
                      v  
                      true(cell(1, 1, x)) ^  
                      true(cell(2, 2, x)) ^  
                      true(cell(3, 3, x))  
                      v  
                      true(cell(1, 3, x)) ^  
                      true(cell(2, 2, x)) ^  
                      true(cell(3, 1, x))
```

Evaluation of Intermediate States

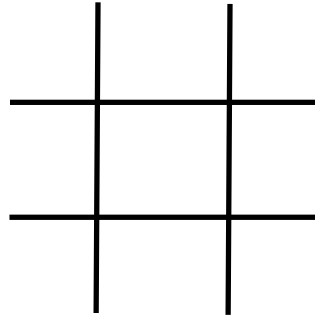

```
eval(goal(xplayer, 100)) after does(xplayer, mark(2, 2))  
> eval(goal(xplayer, 100)) after does(xplayer, mark(1, 1))  
> eval(goal(xplayer, 100)) after does(xplayer, mark(1, 2))
```

Goal Distance (2)

The closer the current value of a functional fluent to the target value, the “less false” is the corresponding goal literal

- Remember how successor relations and order relations can be identified
- These relations define **metrics** Δ on functional fluents wrt. the output argument
- Truth degree of $\text{true}(f(x,a))$ given that $\text{true}(f(x,b))$:

$$(1-p) - (1-p) * \frac{\Delta(b, a)}{|\text{dom}(f(\vec{x}))|}$$

Example: The Goal in Racetrack

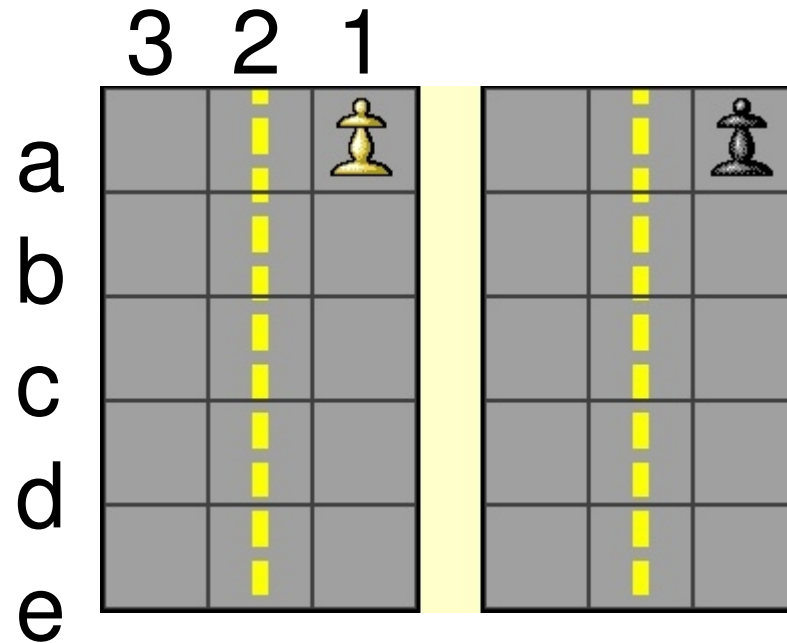

```
goal(white,100) <= true(lane(white,e))  
init(lane(white,a))
```

Evaluation of Intermediate States

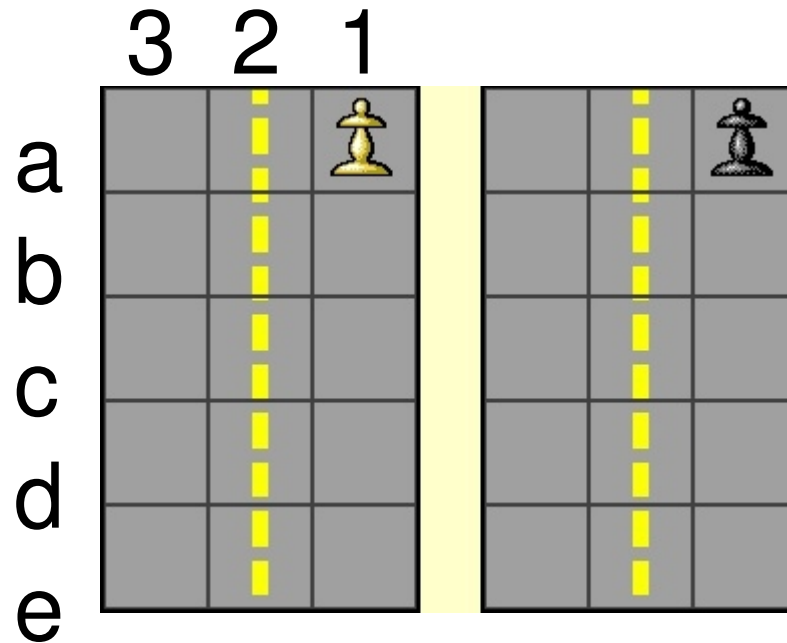

$\Delta(b,e) = 3 < \Delta(a,e) = 4$, hence:

$\text{eval}(\text{goal}(\text{white}, 100))$ after `does(white, move(a, 1, a, 2))`

$< \text{eval}(\text{goal}(\text{white}, 100))$ after `does(white, move(a, 1, b, 1))`

Another Example

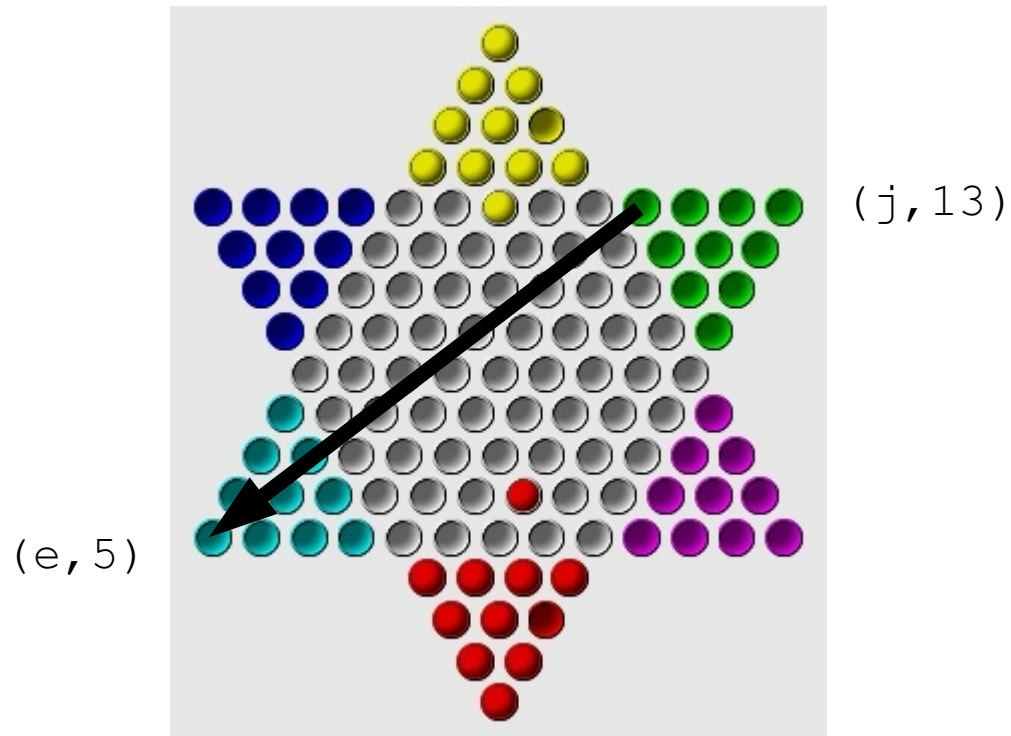

```
init (cell (green, j, 13)) ^ ...
```

```
goal (green, 100) <= true (cell (green, e, 5)) ^ ...
```

Chinese checkers continued

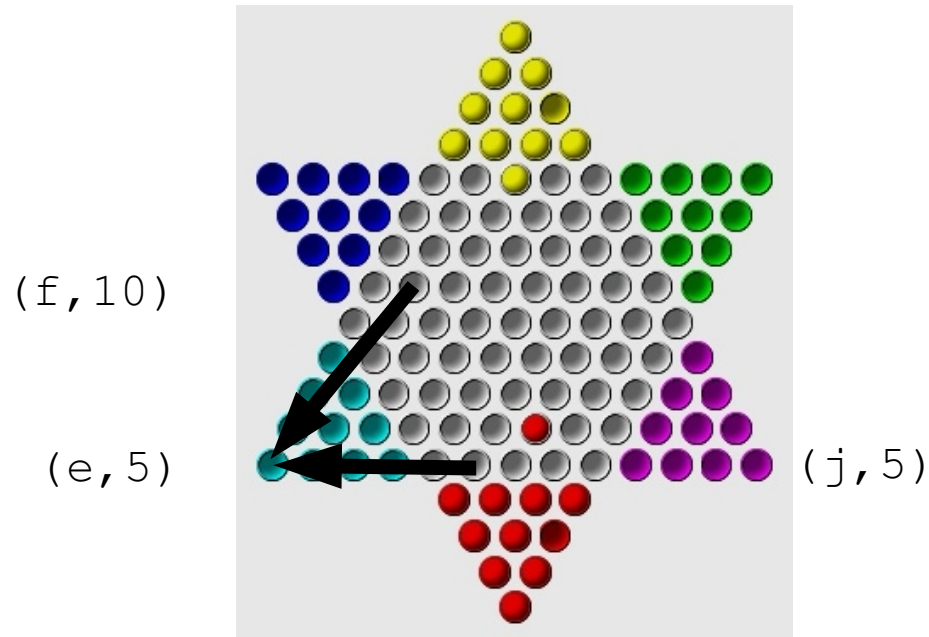

$$\Delta((j,5), (e,5))=5 < \Delta((f,10), (e,5))=6$$

Assessment

Fuzzy goal evaluation works particularly well for games with

- **independent** sub-goals
15-Puzzle
- **converge** to the goal
Chinese Checkers
- **quantitative** goal
Othello
- **partial goals**
Peg Jumping, Chinese Checkers with >2 players

Monte Carlo Tree Search (1)

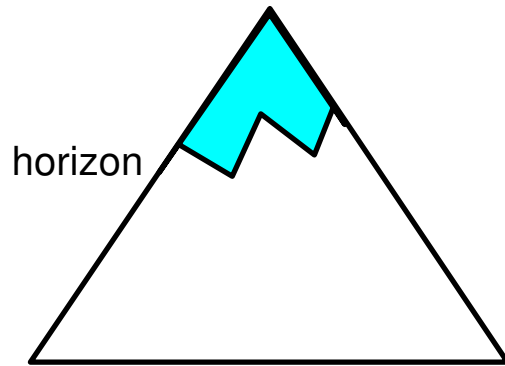

Game Tree Search

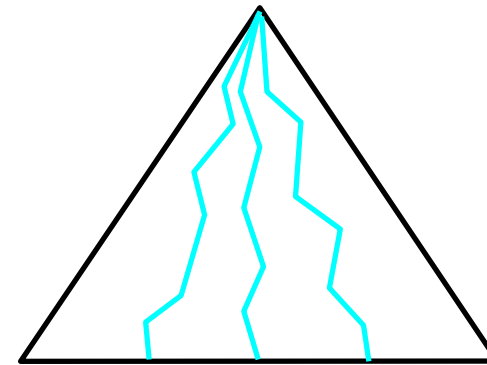

MC Tree Search

Monte Carlo Tree Search (2)

Value of move = Average score returned by simulation

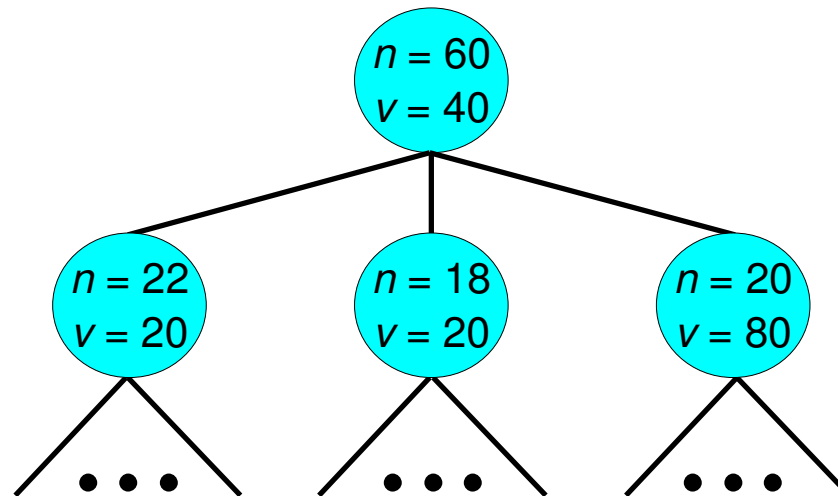

Confidence Bounds

- Play one random game for each move
- For next simulation choose move

$$\operatorname{argmax}_i \left(v_i + C * \sqrt{\frac{\log n}{n_i}} \right) \quad \text{confidence bound}$$

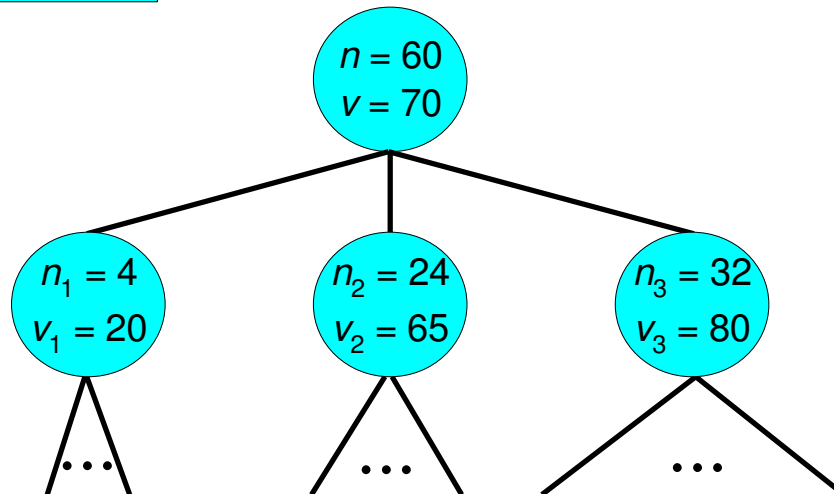

Assessment

Monte Carlo Tree Search works particularly well for games which

- converge to the goal
Checkers
- reward greedy behavior
- have a large branching factor
- do not admit a good heuristics